

Varenummer: 4395000451  
Beskrivelse: Rota-fix spændelement F45x75  
Rustfast stål

## Mål

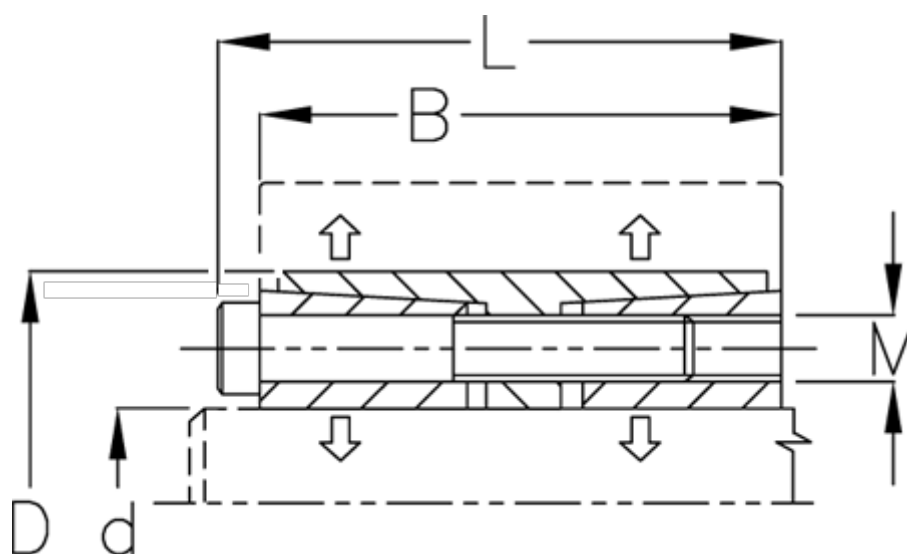

B mm	= 54
d H8 mm	= 45
D mm	= 75
F kN aksialkraft	= 76.7
L mm	= 62
M mm	= M8
Overfladeruhed	= R? ? 3.2 $\mu$ m
P N/mm <sup>2</sup> fladetryk på aksel/nav	= 38

T Nm drejningsmoment	= 1720
Tolerance	= Aksel h8, Nav H8
Ts Nm boltetilspændingsmoment	= 28.7